

Rim

NÁVOD K POUŽITÍ
BEDIENUNGSANLEITUNG
OPERATING INSTRUCTIONS
MODE D'EMPLOI
INSTRUKCJA UŻYTKOWANIA
HASZNÁLATI ÚTMUTATÓ



SPACE SP 1523

SYNCHRO SEF

1

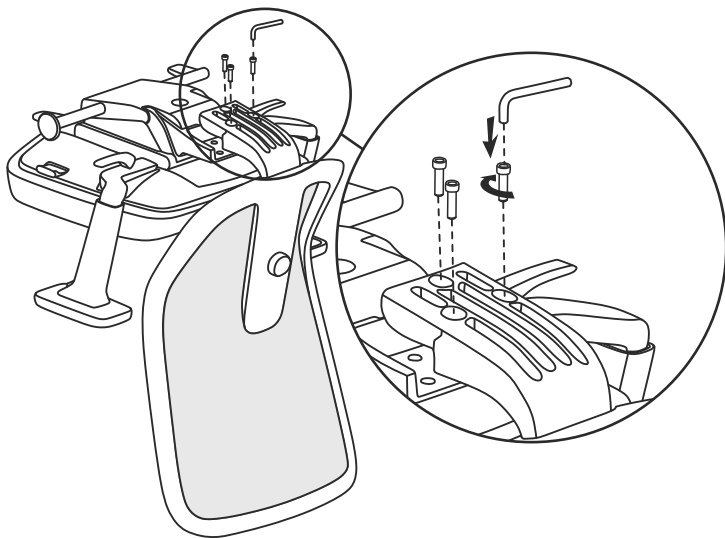

2

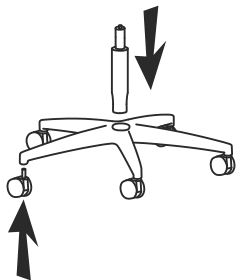

3

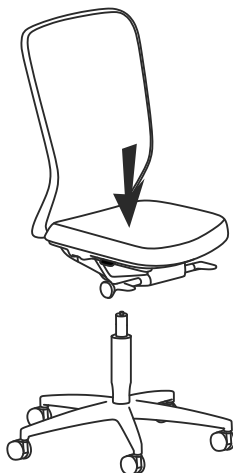

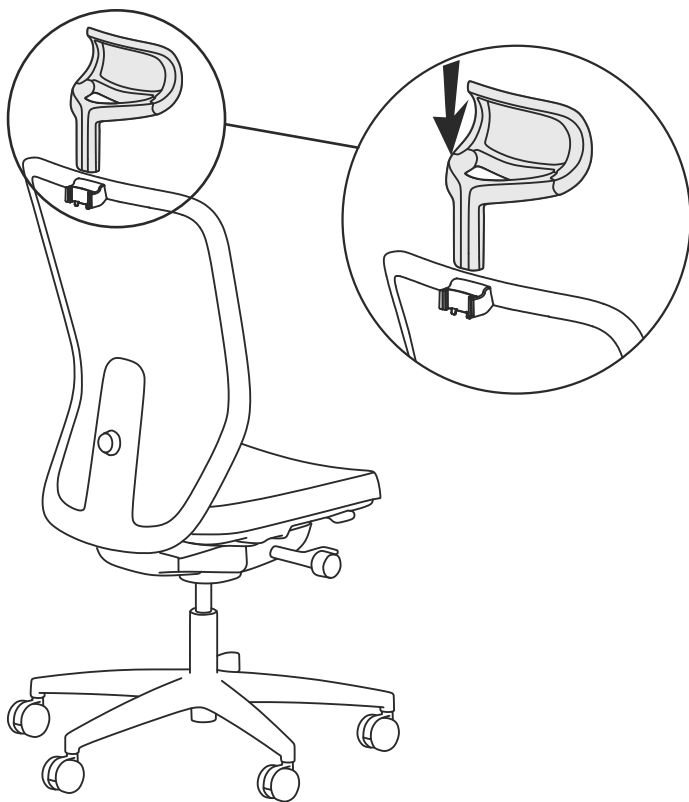

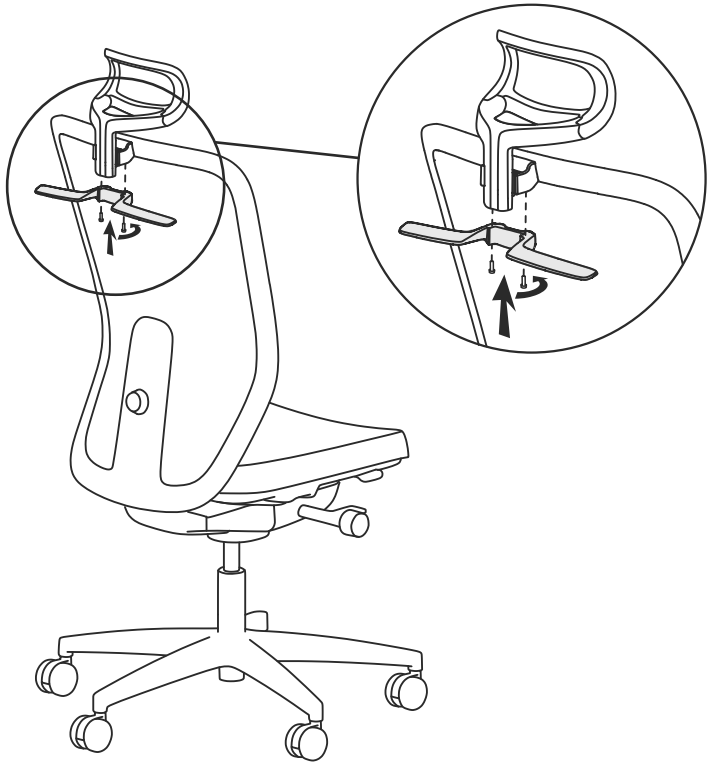

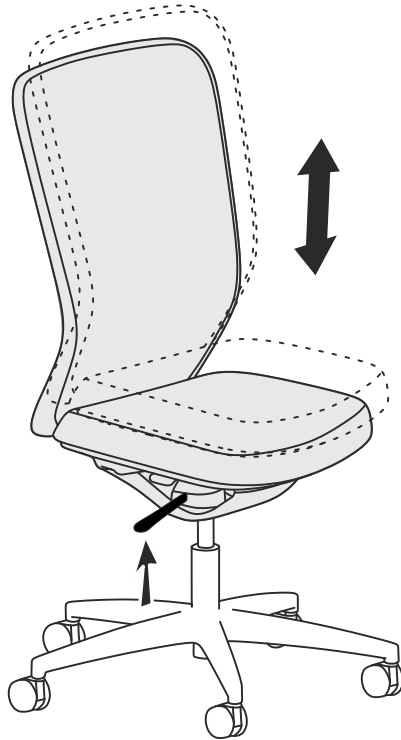

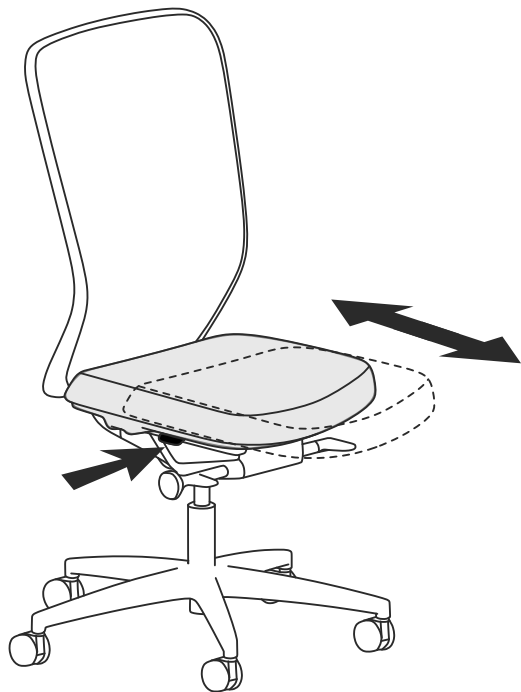

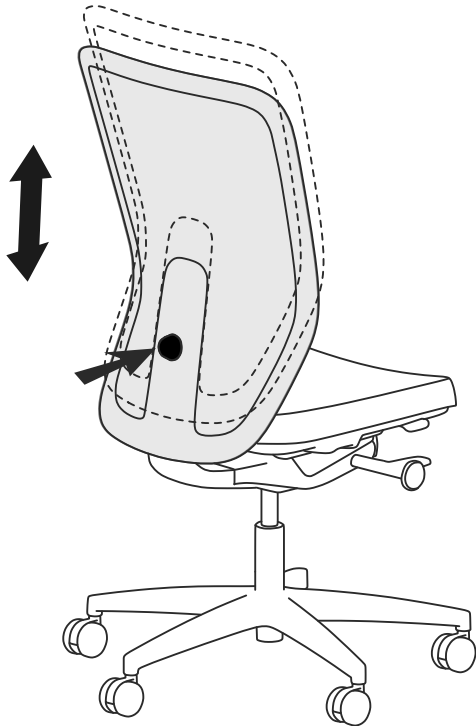



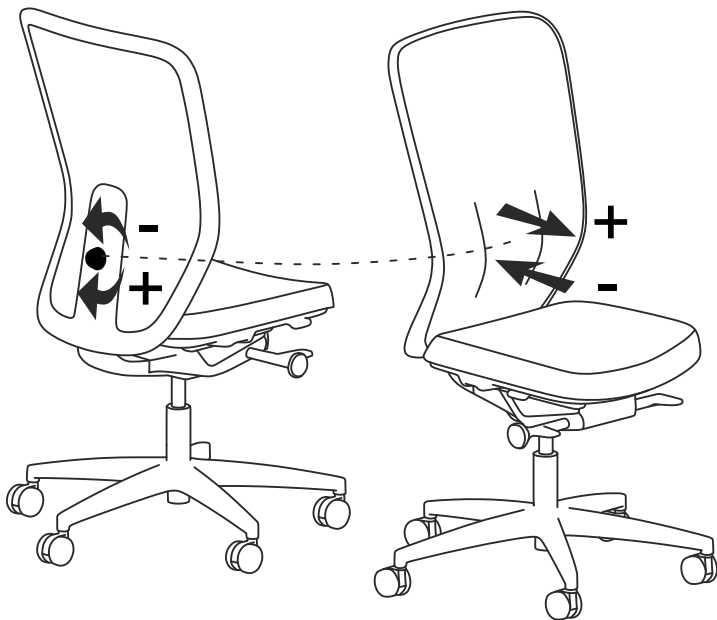

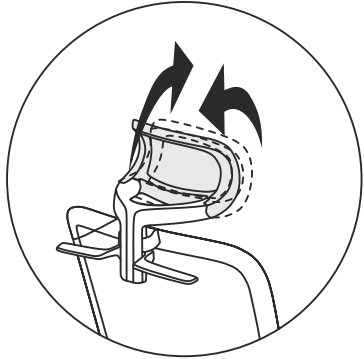

Područky 093 3F
Armlehnen 093 3F
Armrests 093 3F
Accoudoirs 093 3F
Podłokietniki 093 3F
Karfa 093 3F

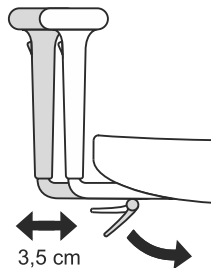
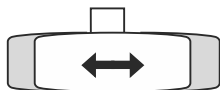
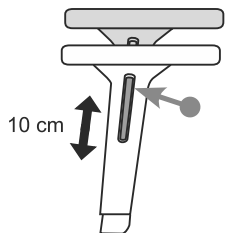

Područky 094 4F
Armlehnen 094 4F
Armrests 094 4F
Accoudoirs 094 4F
Podłokietniki 094 4F
Karfa 094 4F

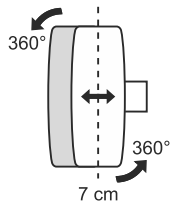
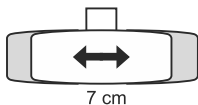
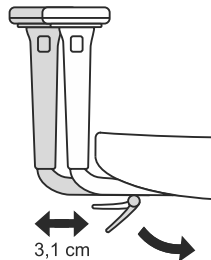
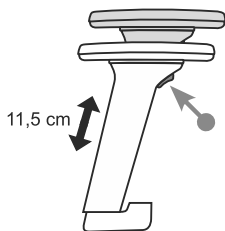

Rim

RIM CZ a.s.

Dr. E. Beneše 1015

765 02 Otrokovice

CZECH REPUBLIC

Tel.: +420 577 112 640

E-mail: info@rim.cz

www.rim.cz

